

NOTES:
 1.MATERIAL:
 HOUSING:THERMOPLASTIC(UL94V-0)
 ACTUATOR:THERMOPLASTIC(UL94V-0)
 TERMINAL:PHOSPHOR BRONZE GOLD PLATED
 FITTING NAIL:BRASS MATTE TIN PLATED
 2.PART NO. SPECIFICATION: 21-035-XXX23-5
 NO.OF CONTACT CODE _____

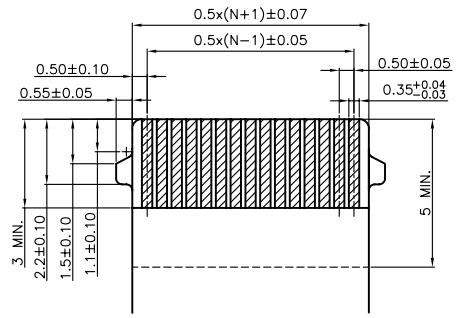

RECOMMENDED FPC DIM.
 RECOMMENDED FPC DIM.

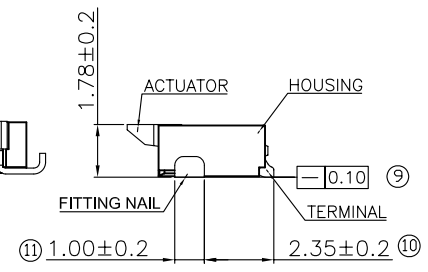
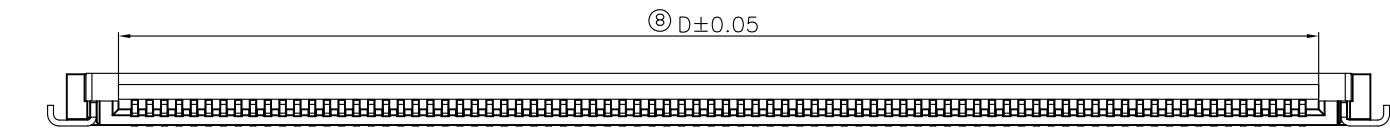
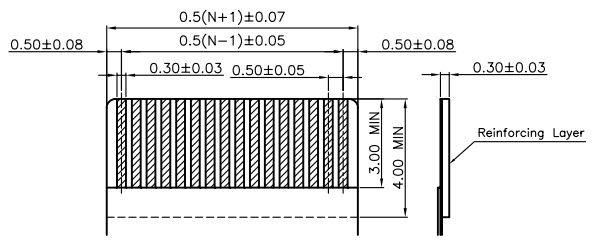
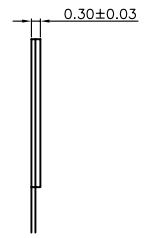

RECOMMENDED FFC DIM
 RECOMMENDED FFC DIM

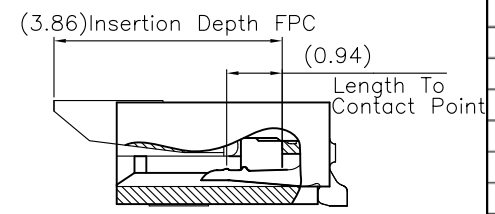

SCALE 2:1

Dimension				
PIN数	A	B	C	D
40	24.10	19.50	22.30	20.60
51	29.60	25.00	27.80	26.10
56	32.10	27.50	30.30	28.60
57	32.60	28.00	30.80	29.10
58	33.10	28.50	31.30	29.60
59	33.60	29.00	31.80	30.10
60	34.10	29.50	32.30	30.60
61	34.60	30.00	32.80	31.10
62	35.10	30.50	33.30	31.60
63	35.60	31.00	33.80	32.10
64	36.10	31.50	34.30	32.60
65	36.60	32.00	34.80	33.10
66	37.10	32.50	35.30	33.60
67	37.60	33.00	35.80	34.10
68	38.10	33.50	36.30	34.60
69	38.60	34.00	36.80	35.10
70	39.10	34.50	37.30	35.60
71	39.60	35.00	37.80	36.10
72	40.10	35.50	38.30	36.60
73	40.60	36.00	38.80	37.10
74	41.10	36.50	39.30	37.60
75	41.60	37.00	39.80	38.10
76	42.10	37.50	40.30	38.60
77	42.60	38.00	40.80	39.10
78	43.10	38.50	41.30	39.60
79	43.60	39.00	41.80	40.10
80	44.10	39.50	42.30	40.60

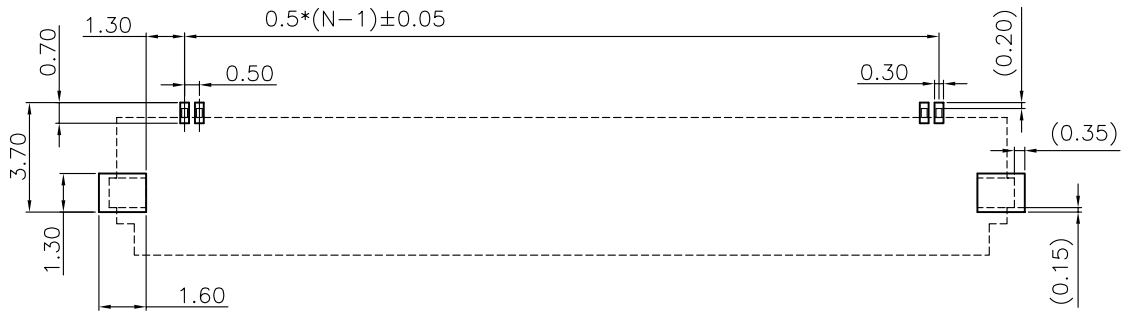

P.C.B LAYOUT REF

SER	AREA	DESCRIPTION	CHK	DATE	UNIT	SIZE
					mm	A4

宇詮實業有限公司
 Onward Industry Co, Ltd.

APPROVED BY	DATE	TITLE
CHECKED BY	DATE	FPC CONN. 0.5P H1.8 FLIP TYPE 成品图
DRAWN BY	DATE	DOCUMENT NO
DRAWING NO	REV	SHEET
21-035-XXX23-5	A	1/1
PAGE	SCALE	
1	1:1	